

SIDEX

L'ART DU REVÊTEMENT

# V-JOINT EMBOUVETÉ (CÈDRE ROUGE)

VJE



REVÊTEMENTS DE DISTINCTION

VJE0014

VJE0016

4"

6"

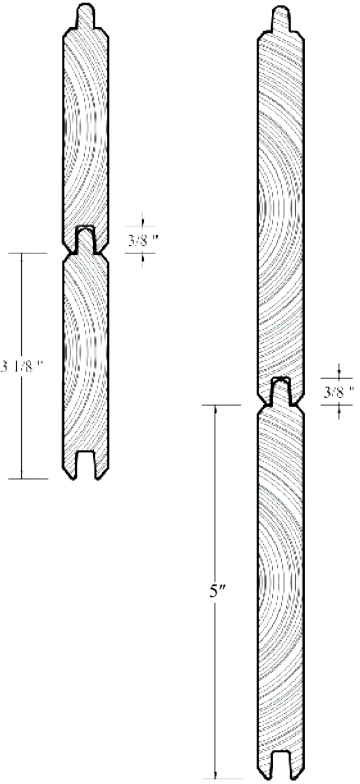

4"

6"

# AUTRES SPÉCIFICATIONS

Veuillez vous référer à l'outil de création de revêtement de notre site web pour connaître les combinaisons possibles et autres options disponibles.

## ESSENCES

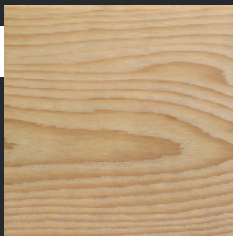

CÈDRE BLANC

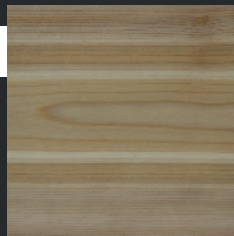

CÈDRE ROUGE

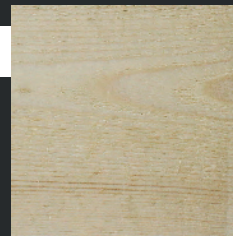

ÉPINETTE

## LARGEURS



4"

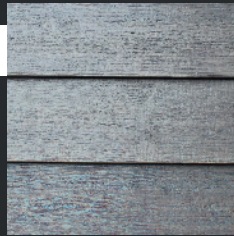

6"



8"

## FINIS

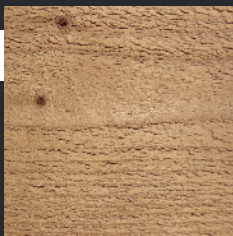

BRUT

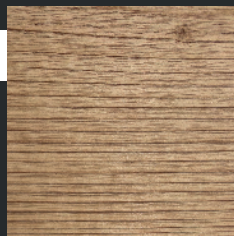

BROSSÉ

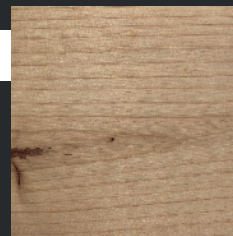

SABLÉ

## FINITIONS

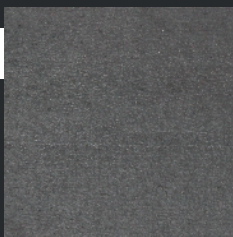

OPAQUE

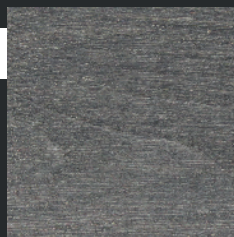

DEUX TONS

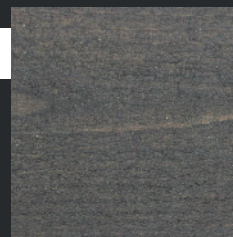

SEMI-TRANSPARENT

# GARANTIES



## OPAQUE



## DEUX TONS



## SEMI-TRANSPARENT



\*Des conditions s'appliquent.

Lambris teint sur 6 faces.  
Longueurs de 4-16' (min. 75% de 14-16' pour les produits standards en épinette).  
Séchage 10-12% HR.