

SIDEX

L'ART DU REVÊTEMENT

V-JOINT EMBOUVETÉ (ÉPINETTE)

VJSC

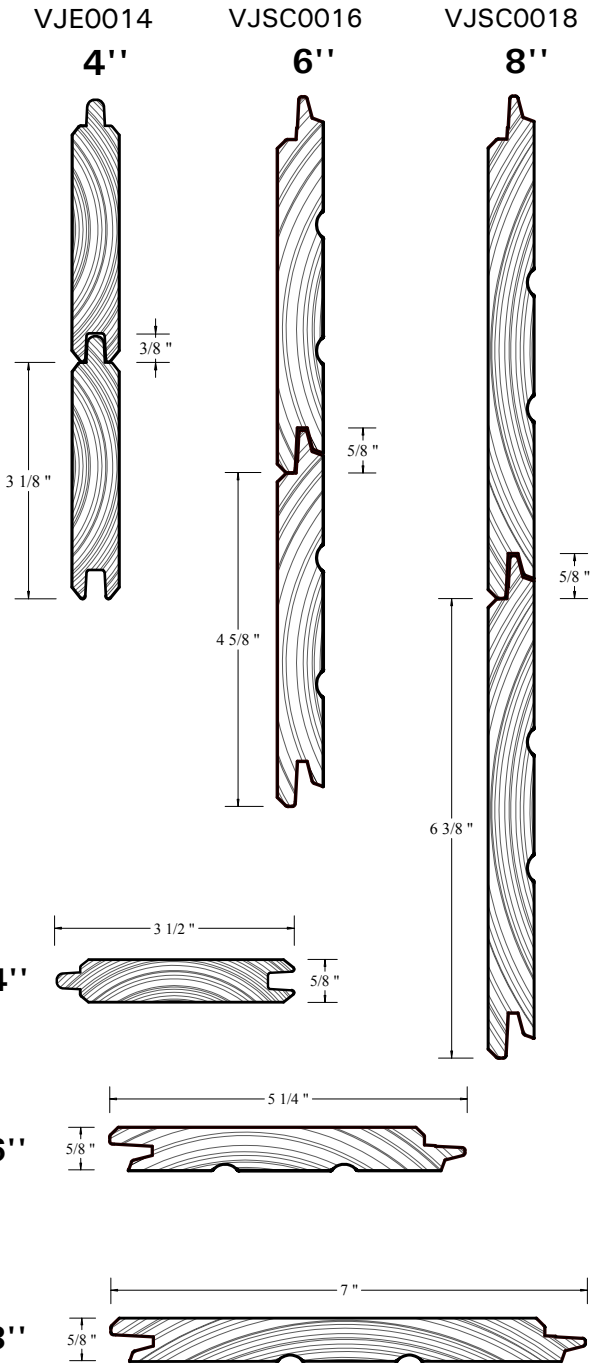

AUTRES SPÉCIFICATIONS

Veuillez vous référer à l'outil de création de revêtement de notre site web pour connaître les combinaisons possibles et autres options disponibles.

ESSENCES

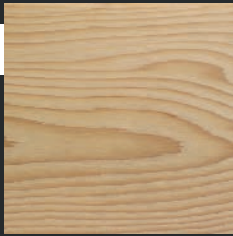

CÈDRE BLANC

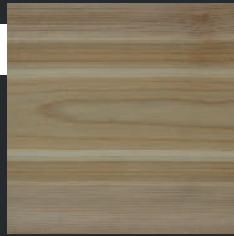

CÈDRE ROUGE

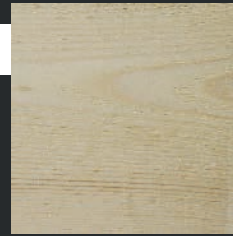

ÉPINETTE

LARGEURS

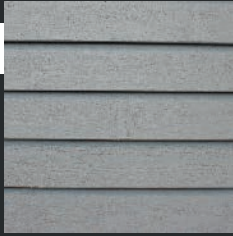

4"



6"

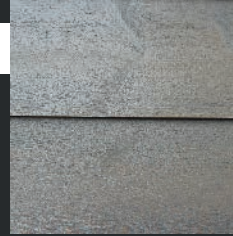

8"

FINIS



BRUT

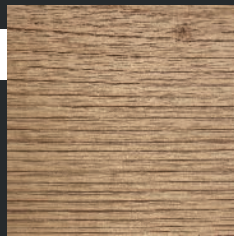

BROSSÉ

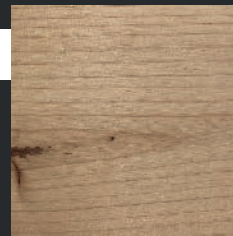

SABLÉ

FINITIONS

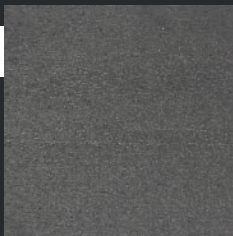

OPAQUE

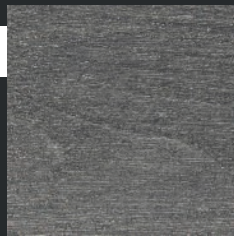

DEUX TONS

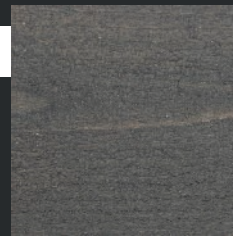

SEMI-TRANSPARENT

GARANTIES



OPAQUE



DEUX TONS



SEMI-TRANSPARENT



*Des conditions s'appliquent.

Lambris teint sur 6 faces.
Longueurs de 4-16' (min. 75% de 14-16' pour les produits standards en épinette).
Séchage 10-12% HR.