

UPDATED
EDITION

Exterior and Interior WALL MANUAL

2020 Edition

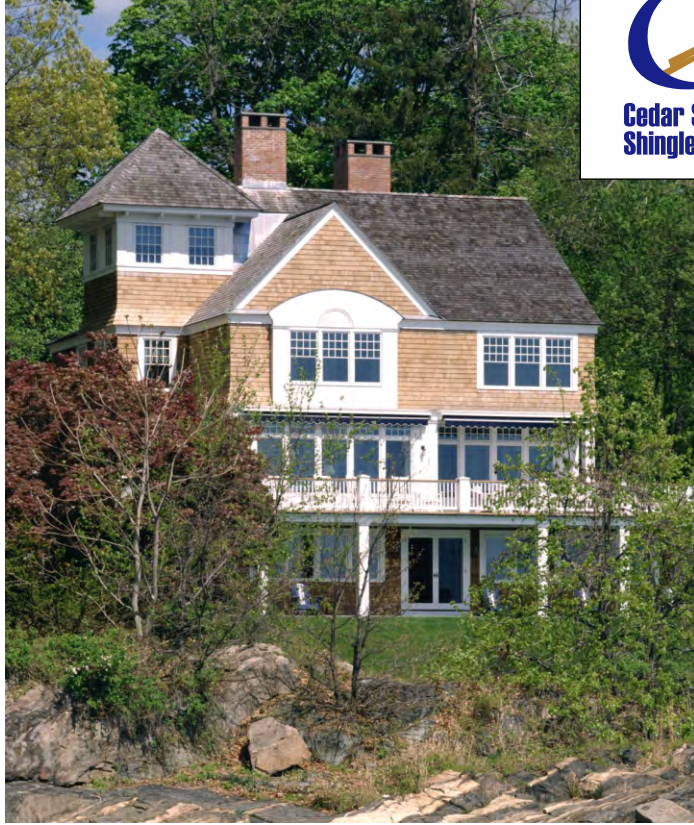

INTRODUCTION

This manual is intended for use with Western Red Cedar and Alaskan Yellow Cedar shingle and shake applications only. Western Red Cedar products manufactured by CSSB members are labeled with the “Certi” brand name. Alaskan Yellow Cedar products manufactured by CSSB members are labeled with “Yellow Cedar” at the top of their label. For ease of reference this manual refers to “Certi-label® Western Cedar” and the term is understood to include both Western Red Cedar and Alaskan Yellow Cedar products manufactured by CSSB members.

Certi-label® Western Cedar shingles and shakes are the ideal exterior wall cladding for new construction and remodeling. They bring life in the form of beauty, texture, durability, insulative quality, and low maintenance to any building. Restyling with Certi-label® Western Cedar shingles or shakes is easily accomplished, whether replacing the previous wall material (re-walling) or applying right over the existing wall (over-walling).

Exterior and Interior Walls Construction Manual

Material for this manual has been compiled from various authoritative sources, and many of the construction methods shown herein have been developed by the shingle and shake specialists in both the United States and Canada. The design and application details and methods of construction reflect current good building practice. Other options are possible but ensure that you check with your local building code official for approval.

COVER CREDITS:

Top
Courtesy: Robert A. Cardello Architects;
Photo Courtesy: Dennis Carbo Photography
Bottom left
Brindisi & Yaroscak Custom Builders, Inc.,
Architect: George Dumitru
Bottom right
Smiros & Smiros Architects, LLP

Certi-label® Products

Certi-label® Western Cedar shingles and shakes manufactured by members of the Cedar Shake & Shingle Bureau® (“CSSB”) are the only products labeled with the “Certi” brand name. Certi-label® Western Cedar shingles and shakes are made by experienced craftsmen who take pride in their trade and the quality of their product. Despite their varying sizes and sometimes remote locations, member mills are bound together by a rigid quality code. Unannounced independent inspections conducted by accredited third party agencies ensure that product quality is maintained. Products are inspected to conform with various local, national and international codes and standards (contact the CSSB for specific details).

All CSSB member product has the mill's distinctive Certi-label® tucked under the bundle strap or printed on the carton. Asking for “the blue label” or “number one blue label” is not specific enough: CSSB members’ products are the only ones with the “Certi” brand name on the label.

Application Notes

Good workmanship is crucial to the integrity of any sidewall system. Installers should read this manual carefully and ensure that they follow proper workmanship practices.

Certi-label® Western Cedar shingles and shakes are applied on walls in a different manner than on roofs. The major point of difference is in permissible weather exposures - on walls the maximum weather exposure is greater than it is on roofs.

A given area of wall, therefore, will require less material than the same area of roof.

Ask for warranty requirements, including product labels, before purchasing product. As usual, always check with your local building code official for requirements in your area.

CONTENTS

Certi-label® Products	pages 1-3
Exterior New Wall Construction	pages 4, 5, 9, 10, 11, 12
Sidewall Fastener Guidelines	pages 6, 7, 8
Exterior Over-Wall and Re-Wall Construction	pages 13, 14
Interior Wall Construction	page 15
Sidewall Application Guidelines	page 16
Sidewall Finishing	pages 17, 18
Sidewall Coverage Tables	pages 19, 20
How to Read a Certi-label®	page 21

Note:

- ONLY experienced professionals who follow proper safety and workmanship practices should implement the information contained herein.
- Different climates have different code requirements. Ensure the right products and installation methods are used per the building code official in your area.
The information in this manual is not intended to supersede local building codes.
- Confirm labels required for warranty registration before purchasing product. Ensure details are listed on purchase order.
- Refer to www.cedarbureau.org for project inspiration and photo portfolio.

Note: This manual replaces all previous versions of the “Design and Application Manual for Exterior and Interior Walls” and “Exterior and Interior Wall Manual”.

This manual presents best practices developed over more than a century of Cedar Shake and Shingle Bureau (“CSSB”) history. Please contact CSSB technical staff with Certi-label® product or installation questions. The contents of this manual are not intended to supersede local jurisdictions requirements or building code. ALWAYS check with your local code jurisdiction for approval of any installation modifications, including accessory building materials.

Check with building code official for local jurisdiction requirements

CERTIGRADE® WESTERN CEDAR SHINGLES

Number 1 Blue Label®



The premium grade of shingles for sidewalls and roofs. These top-grade shingles are 100% heartwood, 100% clear and 100% edge grain. Available in 16" or 18" or 24" lengths.

Number 2 Red Label



A good grade for many applications. Not less than 10" clear on 16" shingles, 11" clear on 18" shingles and 16" clear on 24" shingles. Flat grain and limited sapwood are permitted in this grade.

Number 3 Black Label



A utility grade for economy applications and secondary buildings. Not less than 6" clear on 16" and 18" shingles, 10" clear on 24" shingles.

Number 4 Undercoursing



A utility grade for undercoursing of double coursed sidewalls only. Not a roofing material and not to be used as a starter course for roofs.

CERTI-LABEL® WESTERN CEDAR SHAKES

Certi-Split® Handsplit Shakes



These shakes have split faces and sawn backs. Cedar logs are first cut into desired lengths. Blanks or boards of proper thickness are split and then run diagonally through a bandsaw to produce two tapered shakes from each blank. Available in Premium Grade (100% edge grain) or Number 1 Grade.

Certi-Sawn® Tapersawn Shakes



These shakes are sawn both sides. Premium and Number 1 Grades are the most common. Premium Grade is 100% edge grain, 100% clear and 100% heartwood. Number 1 Grade allows up to 20% flat grain in each bundle. Number 2 and 3 Grades are also available.

Certi-Split® Tapersplit Shakes



Produced by hand, using a sharp bladed steel froe and a mallet. The natural shingle-like taper is achieved by reversing the block, end-for-end, with each split. Premium Grade only.

Certi-Split® Straight-Split Shakes



Produced by machine or in the same manner as tapersplit shakes except that by splitting from the same end of the block, the shakes acquire the same thickness throughout. Premium Grade only.

Note: Western Cedar's natural color varies.

CERTI-LABEL® WESTERN CEDAR SIDEWALL PRODUCTS

Certigrade® Rebutted & Rejointed Shingles



Also known as R&R products, these materials have the same specifications as Number 1 and Number 2 Certigrade® shingles, but they are machine re-trimmed for parallel edges and with smooth butts sawn at right angles where a uniform appearance is desired. They are primarily used for sidewall applications. Rebutted & rejointed shingles are also available with a smooth sanded face, with the length of the sanded face at a length greater than the maximum exposure. They are manufactured from 16", 18" and 24" lengths.

Certigroove® Machine Grooved Shingles



Machine grooved shingles are manufactured as a rebutted & rejointed shingle with one face striated for a length greater than the maximum exposure. Machine grooved products are for sidewall applications only, and are remanufactured from 16", 18" and 24" shingles.

Note: Roofing products can be used for sidewall applications but will yield a less even appearance due to increased tolerance allowances of edges.

Certi-Cut® Shingles

Diagonal

Fish-scale

Diamond

Square

Half Cove

Hexagonal

Octagonal

Round

Arrow



CERTI-CUT® SHINGLES These shingles are 5" wide and are manufactured from 16" and 18" lengths. An 18" length, 96-piece carton will cover 25 square feet at 7 1/2" exposure. Nine of the most popular designs are shown. Certi-Cut® shingles can also be custom produced to meet individual design specifications.

Sidewall Carton Packaging Example

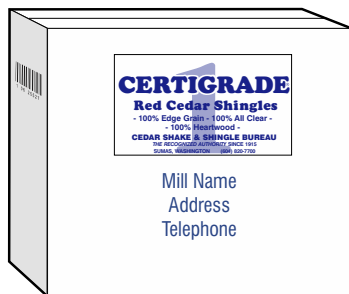

Half Carton

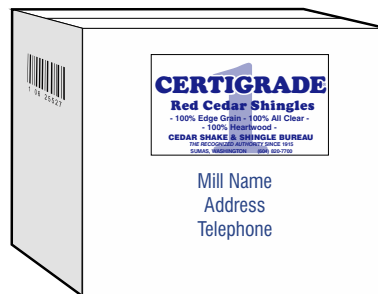

Full Carton

Look for the Certi-label® on the carton.

Check with building code official for local jurisdiction requirements



Pressure-Impregnated Treated Products

Certi-label® products can also be treated. Products are available either fire-retardant-treated OR preservative-treated. Special care must be taken to follow the treatment company’s recommended installation instructions.



Certi-Guard® Fire-Retardant Treated Western Cedar Shingles and Shakes

Number 1 Grades of Certigrade® shingles, and Premium and Number 1 Grades of Certi-Split shakes® and Certi-Sawn® shakes are available pressure-impregnated treated with fire retardants. Contact the treatment company for treatment warranty information, accessory product requirements (including recommended fastener types) and application details for treated Western Cedar material. Local code jurisdictions may have additional information regarding applications in specific areas.



Certi-Last® CCA Preservative-Treated Western Cedar Shingles and Shakes

Number 1 Grades of Certigrade® shingles, and Premium and Number 1 Grades of Certi-Split® shakes and Certi-Sawn® shakes are available preservative-treated by pressure impregnation process. This product is ideal in areas of high humidity. Specify the Certi-Last® treating label for this extra protection. Contact the treatment company for treatment warranty information, accessory product requirements (including recommended fastener types) and application details for treated Western Cedar material.

Note:

- Once Western Cedar shingles and shakes are pressure-impregnated treated you must contact the treatment company to determine if a finish, such as paint or stain or cleaning solution/agent, is allowable.
- Confirm product labels required for warranty registration BEFORE purchasing product. Ensure details are listed on purchase order.

Certi-label® Sidewall Application Tips

Certi-label® Western Cedar shingle and shake size, exposure, width of joints, width of product, kiln versus air-drying process, moisture content and the local environment will all affect the expansion/contraction of Certi-label® Western Cedar sidewall products. These factors should always be taken into consideration when

determining the installation details and adequate spacing needed for your specific project. Consult with your installer and refer to this manual for more lateral spacing details.

It is suggested that shingles from several job-specific boxes are blended during the installation process.

Design and Application Details

The instructions given here are not meant to supersede local code requirements. Check with your local building code official for their preference in your area.

Preparation - Be sure that the walls are smooth, without protuberances. Nail ends or points should be removed or pounded flush.

The CSSB recommends installing over plywood panel or dimensional lumber sheathing. If other sheathing materials are approved for use by your local building code official, the holding power of the fasteners should also be considered carefully.

Underlayment - The CSSB recommends No. 30 felt (ASTM D226 Type II or ASTM D4869 Type IV) underlayment material. Apply it horizontally, with a staple gun, starting at the base of the wall, with a 2" horizontal overlap with each succeeding course, and a 6" overlap vertically when starting a new roll. Wrap the felt underlayment 4" each way around both inside and outside corners.

Corner Boards - Install corner boards (Figure 8) at this time.

Flashing - Flashings associated with doors, windows, and penetration details should be in accordance with local building code requirements.

Laying Out - Determine the number of Certi-label® courses by measuring the height of the wall at the lowest part of the foundation, from a point 1" below the top of the foundation, to the top of the wall. Divide the height into equal parts,

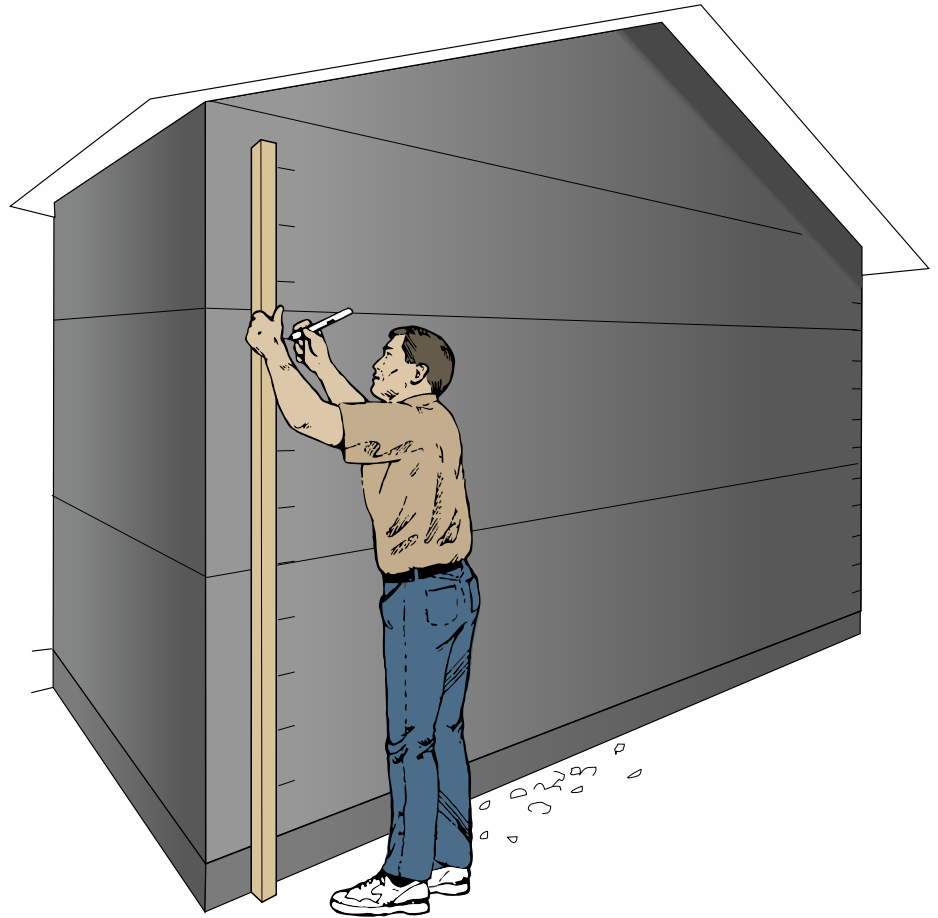

Figure 1: Storypole

corresponding closely to the weather exposure, but not exceeding the maximum weather exposure recommended. Transfer this measurement and the number of Certi-label® courses to a storypole (Figure 1), to lay out courses on all other walls. Whenever possible butt lines should align with tops or bottoms of windows or other openings, and for appearance the exposure of the final course at the top should match those below.

Certi-label® Western Cedar shingle and shake size, exposure, width of joints, width of product, kiln versus air-drying process, moisture content and the local environment will all affect the expansion/contraction of Certi-label® Western Cedar sidewall products. These factors should always be taken into consideration when determining the installation details and adequate spacing needed for your specific project. Consult with your installer and refer to Figure 2: Spacing Detail.

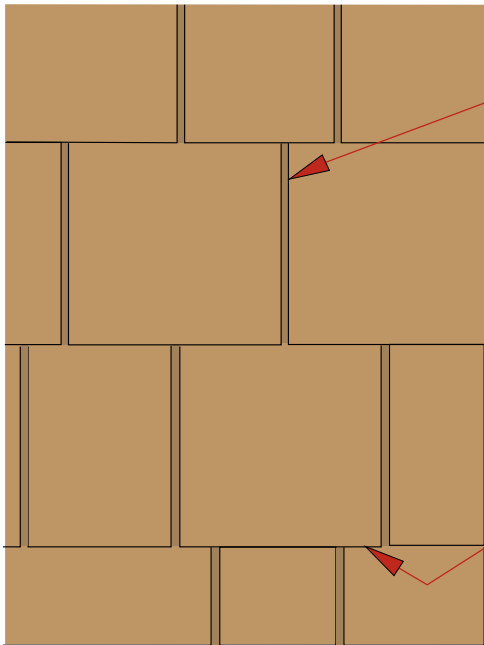

Figure 2: Spacing Detail

SPACING DETAIL

- Number 1 Grade Certi-label® Western Red Cedar shingles shall be spaced 1/8" to 1/4" apart (keyways are 1/8" to 1/4" wide).
- Number 1 Grade Certi-label® Yellow Cedar shingles shall be spaced 3/16" to 5/16" apart (keyways are 3/16" to 5/16" wide).
- These joints allow for expansion and prevent possible "buckling." For every 4" width of dry Certi-label® Western Cedar shingle material, the product will expand approximately 1/8". Therefore space keyways accordingly, i.e. 12" shingle is expected to have approximately 3/8" expansion.
- Allow minimum 1/4" to 3/8" keyway spacing for Number 2 Grade Rebutted and Rejointed Certi-label® Western Red Cedar shingles.
- Leave a side lap of at least 1 1/2" between joints in adjacent courses.

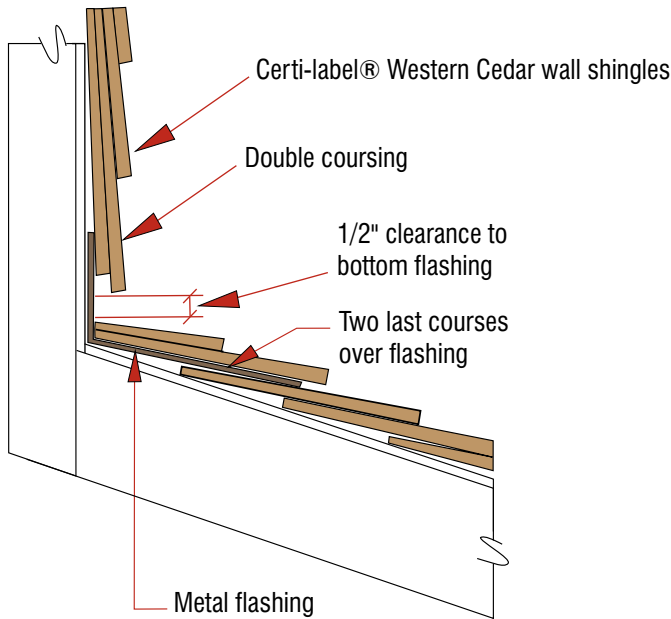

Figure 3a: Flashing

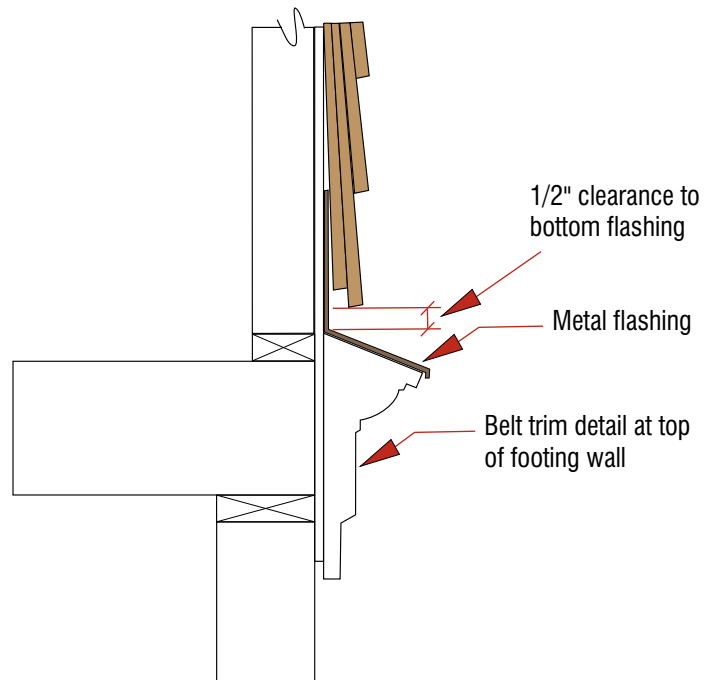

Figure 3b: Flashing

Figures 3a and 3b: To prevent the wicking of water, which may cause staining, keep a 1/2" clearance between the first course of Certi-label® products from all surfaces below.

Nails

Each Certi-label® Western Cedar shingle or shake should be applied with two fasteners. Nails **must be** stainless steel **Type 316 in locations within fifteen (15) miles of salt water**. For locations outside the salt water zone - nails **must be** stainless steel **Type 304, Type 316, or hot-dipped zinc coated galvanized conforming to a coating weight of ASTM A 153 Class D (1.0 oz/ft²)**. Stainless steel nails are a better value and offer the highest degree of corrosion resistance. Contact the nail manufacturer for further information to ensure the nails used comply with listed requirements and are correct for your application. Minimum nail lengths are shown in the fastener chart on page 8. In double course applications, the exposed Certi-label® Western Cedar shingle or shake shall be face-nailed with two nails (as above), driven 2" above the butt line, and 3/4" from each edge.

Certi-label® Western Cedar shingles wider than 10" require 1 additional nail driven near the center of the shingle. Alternatively, split the shingle into 2 smaller width shingles.

**DO NOT USE
ELECTROGALVANIZED ("EG") FASTENERS**

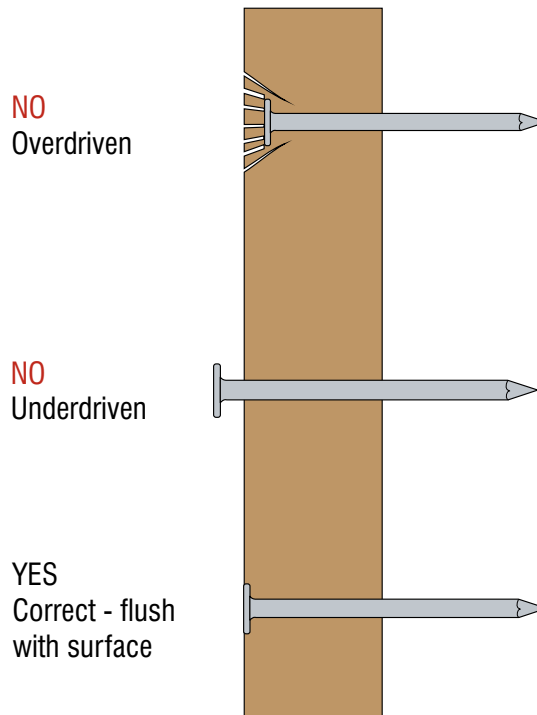

Figure 4a: Nail Driving Detail

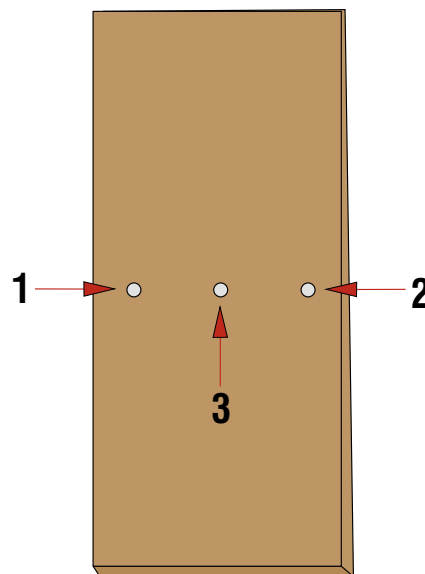

Figure 4b: Wide Shingle Fastener Detail

Staples

If you choose to use staples they **must be** stainless steel **Type 316** in locations within fifteen (15) miles of salt water. For locations outside of the salt water zone - stainless steel staples **Type 304** or **Type 316** **must be** used.

Two staples should be driven per Certi-label® Western Cedar shingle or shake with the staple crowns 7/16" minimum horizontal, maximum 3/4" horizontal, to the Certi-label® Western Cedar shingle or shake butt. Staples are driven in the same location as nails relative to the sides and overlapping butt line. For Certi-label® Western Cedar shingles up to 10" wide, place two staples in each shingle 3/4" from each edge. Certi-label® Western Cedar shingles wider than 10" require an additional staple driven near the center of the shingle. Alternately, split the shingle into 2 smaller width shingles.

Fasteners should be long enough to penetrate into the sheathing at least 3/4" or all the way through and driven flush with the surface of the Certi-label® Western Cedar shingle or shake. In all applications, staples shall be concealed by the course above.



Example of a severely corroded electrogalvanized fastener. Ensure the correct fasteners are used. Corroded fasteners lead to serious sidewall system failures as well as unsightly staining.

Notes:

Underdriving or overdriving any fastener will affect the integrity of the Certi-label® Western Cedar sidewall system.

DO NOT USE ELECTROGALVANIZED (EG) FASTENERS. Ensure the fasteners used comply with listed requirements. Nails are preferred, for aesthetic reasons, in sidewall application using exposed fasteners.

Some nail manufacturers offer nails specifically for wood shake or shingle sidewall application. Contact the nail manufacturer for further information to ensure the fasteners used comply with listed requirements and are correct for your application.

The CSSB and building code require stainless steel Type 316 fasteners in locations within fifteen (15) miles of salt water. See details herein for more specifics.

Pressure Impregnated Treated Shakes and Shingles

Fasteners used with fire-retardant (Certi-Guard®) or preservative treated (Certi-Last®) Western Cedar shakes or shingles **must be** stainless steel Type 316. For specifics on installation, accessory building materials (flashing, etc.) finishes and maintenance please contact the treatment company directly.

Ring shank nails are used for better withdrawal resistance and in designated high wind zone areas.

The information on this page is not meant for sidewall pre-made panel applications. Please contact the manufacturer for specific panel details.

The information in this manual is not intended to supersede local building codes.

Single Course Sidewall Fasteners		Double Course Sidewall Fasteners	
Product Type	Nail Type & Minimum Length	Product Type	Nail Type & Minimum Length
Certigrade® R&R and Sanded Shingles	Type (in)	Certigrade® R&R and Sanded Shingles	Type (in)
16" and 18" Shingles	3d Box 1 1/4	16", 18" and 24" Shingles	5d Box 1 3/4 or same size casing nails
24" Shingles	4d Box 1 1/2	Certigroove® Shingles	Type (in)
Certigroove® Shingles	Type (in)	16", 18" and 24" Shingles	5d Box 1 3/4
16" and 18" Shingles	3d Box 1 1/4	Certi-Split® & Certi-Sawn® Shakes	Type (in)
24" Shingles	4d Box 1 1/2	18" Straight-Split Shakes	7d Box 2 1/4 or 8d 2 1/2
Certi-Split® & Certi-Sawn® Shakes	Type (in)	18" and 24" Handsplit Shakes	7d Box 2 1/4 or 8d 2 1/2
18" Straight-Split Shakes	5d Box 1 3/4	24" Tapersplit Shakes	7d Box 2 1/4 or 8d 2 1/2
18" and 24" Handsplit Shakes	6d Box 2	18" and 24" Tapersawn Shakes	7d Box 2 1/4 or 8d 2 1/2
24" Tapersplit Shakes	5d Box 1 3/4		
18" and 24" Tapersawn Shakes	6d Box 2		

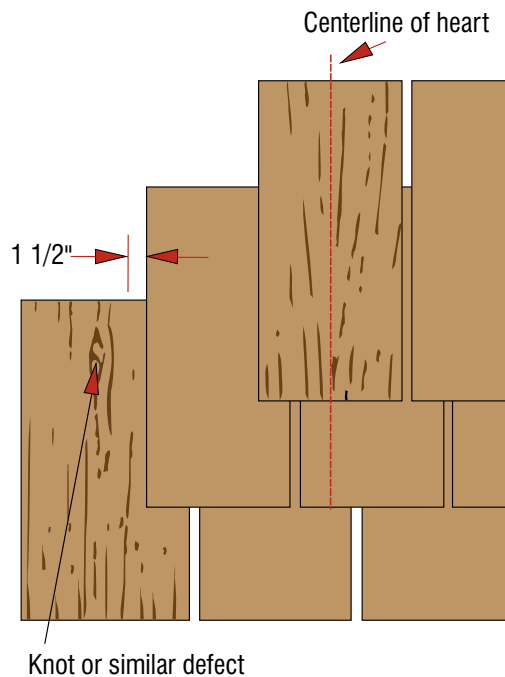

Figure 5: Course Alignment

DO NOT USE ELECTROGALVANIZED ("EG") FASTENERS

Single Coursing

Double the starting course at the base of the wall (Figure 6). For Number 1 Grade Certi-label® Western Red Cedar shingles apply with 1/8" to 1/4" keyway space and for Number 1 Grade Yellow Cedar shingles, apply with 3/16" to 5/16" keyway space between the Certi-label® shingles, giving a pronounced individual effect to each course.

Offset the side joints in any one course at least 1 1/2" over joints in adjacent courses (Figure 2).

Use a straight edge, nailing it lightly to the wall with the edge at the butt line (to keep courses straight and level). Check for level every 3 or 4 courses.

This wall application features concealed nailing (Figure 6), with nails driven approximately 1" above the butt line of the succeeding course. With Certi-label® Western Cedar shingles wider than 10", drive one nail near the center or split wide shingle into two smaller width shingles.

Because Certi-label® Western Cedar shingles vary in width there should be little waste. At corners, or at door or window frames, you may have to trim a selected Certi-label® Western Cedar shingle slightly.

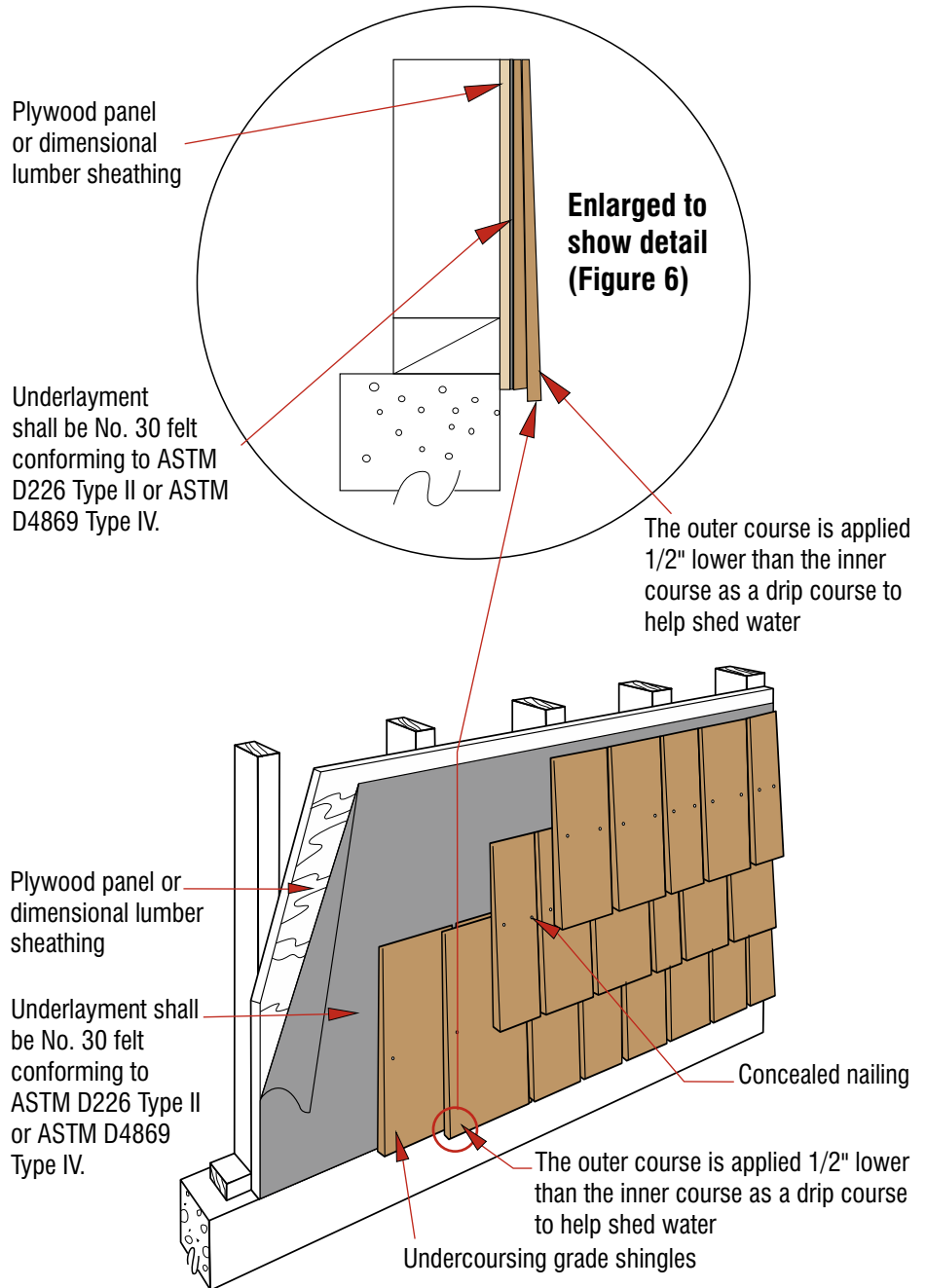

Figure 6: Single Coursing

Note:

The CSSB recommends installing **over plywood panel** or dimensional lumber sheathing. If other sheathing materials are approved for use by your local building code official, the holding power of the fasteners should also be considered carefully. Consider using ring shank nails. Contact local building code official for **substrate (plywood)** attachment fastener detail.

All figures depict shingle applications. **DO NOT** interlay shingles or shakes with felt on sidewall applications.

The Cedar Shake & Shingle Bureau® recommends that underlayment shall be No. 30 felt conforming to ASTM D226 Type II or ASTM D4869 Type IV. Check with your local building code official for any questions about alternative underlayment materials.

Double Coursing

To obtain an attractive wall characterized by wide weather exposures and deep shadow lines, Certi-label® Western Cedar shingles and shakes can be applied double coursed. This method offers economy because of the wide exposures of the outer course and the use of less expensive undercoursing Certi-label® Western Cedar shingles for the under layer (Figure 7a). For double coursing exposure details refer to the chart on page 16.

In double coursing, the bottom or starter course is laid triple with two undercourse Certi-label® Western Cedar shingles or one undercourse Certi-label® Western Cedar shingle over a wood lath and then the outer course. This gives the bottom course the same slant as succeeding courses. All outer courses are applied 1/2" lower than the undercourse (Figure 7a). A straight edge can be used to facilitate placement and nailing of both the undercourse and exposed course.

Undercourse Certi-label® Western Cedar shingles are fastened at the top with one nail or staple in the center. The exposed Certi-label® Western Cedar shingle or shake is face-nailed with two casing-type nails, driven approximately 2" above the butt line, 3/4" from each edge. Certi-label® Western Cedar shingles wider than 10" require 1 additional nail and this nail is driven near the center of the shingle.

The CSSB recommends installing over plywood panel or dimensional lumber sheathing. If other sheathing materials are approved for use by your local building official, the holding power of the fasteners should also be considered carefully.

Note: Cutting the shingle at the bottom avoids bulging or sidewall getting thicker with each adjacent course.

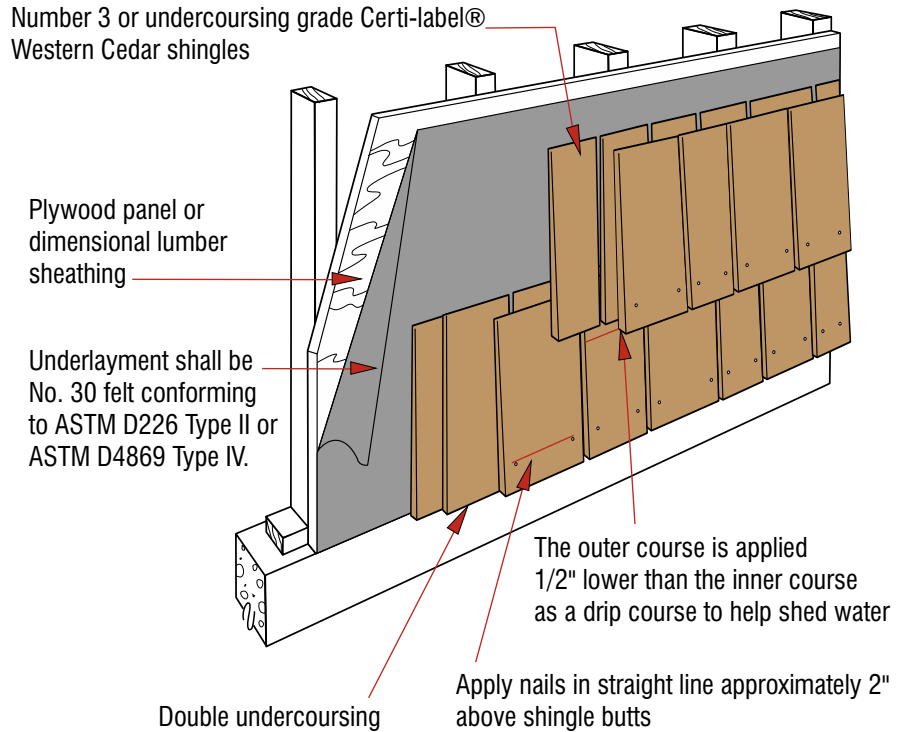

Figure 7a: Double Coursing

Note: Consult your local building code official about the size and height (min 3") of the step flashing

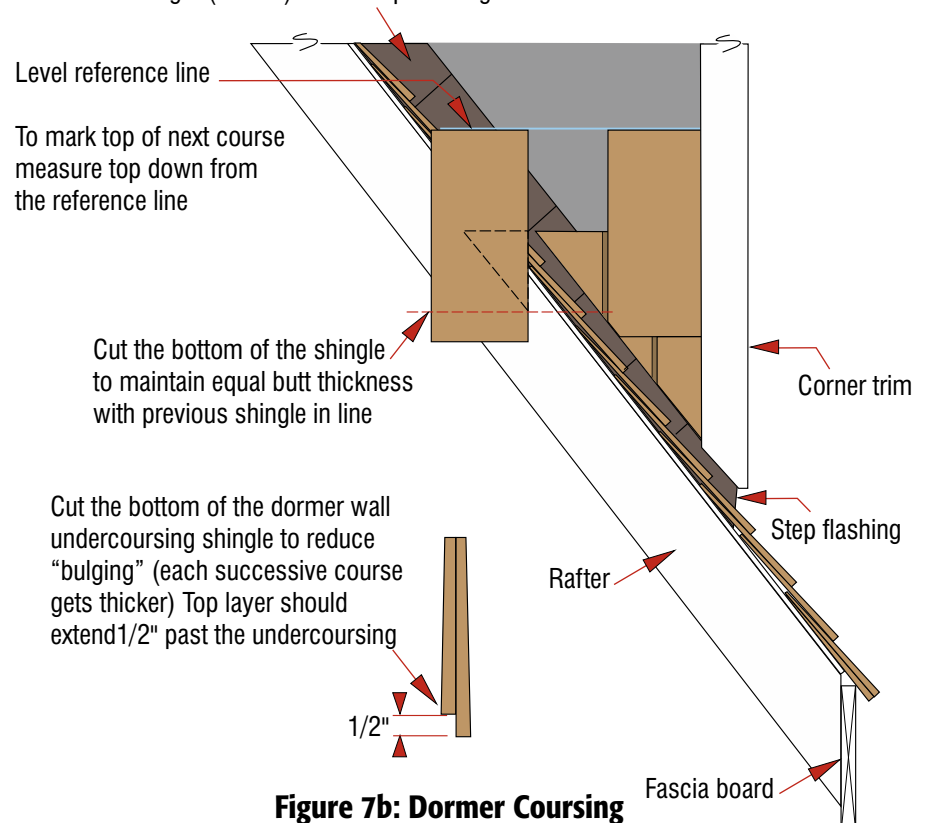

Figure 7b: Dormer Coursing

Corners

Neatly fitting inside or outside corners are easily made. It is standard practice to lace outside corners (Figure 8e). On wide exposures this method requires small nails near the Certi-label® Western Cedar shingle butts to tighten and hold the lapped corners. For these corners use only nails that are corrosion resistant. In double course applications, the exposed Certi-label® Western Cedar shingle or shake shall be face-nailed with two hot-dipped galvanized or stainless steel casing nails, driven 2" above the butt line, and 3/4" from each edge. Certi-label® Western Cedar shingles wider than 10" require 1 additional nail driven near the center of the shingle. Corner boards also can be used to advantage by nailing a 1" x 4" cedar board to a 1" x 3" cedar board, then attaching the preassembled corner to the building (Figure 8a).

It is good practice to use flashing behind Certi-label® Western Cedar shingles or shakes at the inside and outside corners. They may be butted against a square wood strip (Figure 8b), or they may be fitted one course to the other (Figure 8d). When the latter method is used, courses must be completed on each wall progressively, and can be best applied by working from the corners while alternately fitting one course to the other. (Figure 9).

It is preferred practice to install inside/outside corner flashing to safeguard against the cracking or tearing of No. 30 felt (ASTM D226 Type II or ASTM D4869 Type IV) underlayment at these corners.

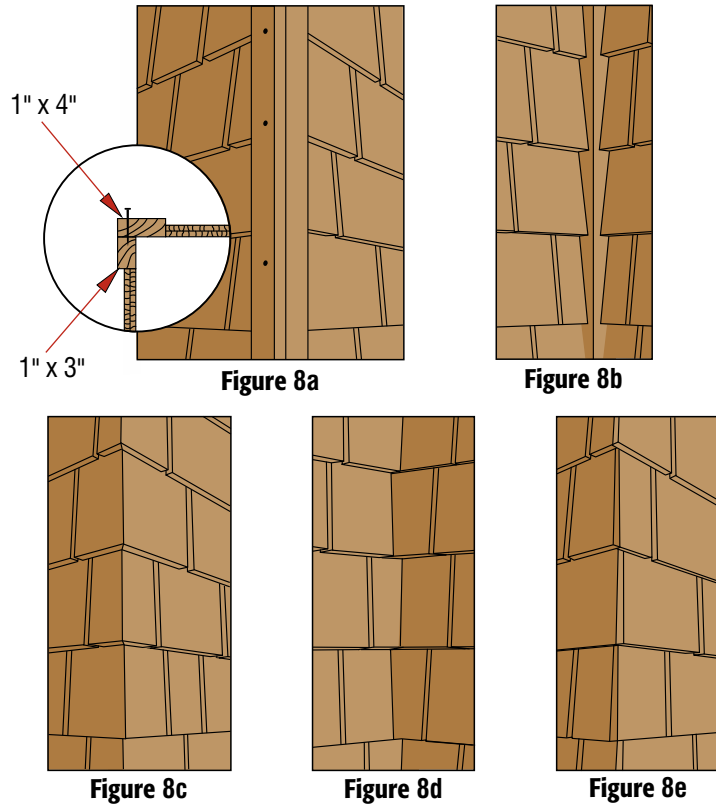

- a) Certi-label® Western Cedar shingles butted against corner boards
- b) Certi-label® Western Cedar shingles butted against square wood strip, flashing behind
- c) Mitered corner
- d) Laced inside corner with flashing behind inside strip on corner
- e) Alternated laced outside corner

Figures 8a-8e: Corner Option Details



Figure 9: Fitting Laced Corner Courses

Design and Application Instructions

Staggered Butt Coursing

For single course application, an attractive effect can be made by staggering the butt of the Certi-label® Western Cedar shingle from the horizontal line. Apply the Certi-label® Western Cedar shingle irregularly at variable distances below (but not above) the horizontal line.

Staggered butt applications are made by shortening the exposure less than the greater maximum exposure. No Certi-label® Western Cedar shingles or shakes shall be applied greater than the maximum exposure allowed. Check with your local building code official for approval of the staggered butt coursing installation method.

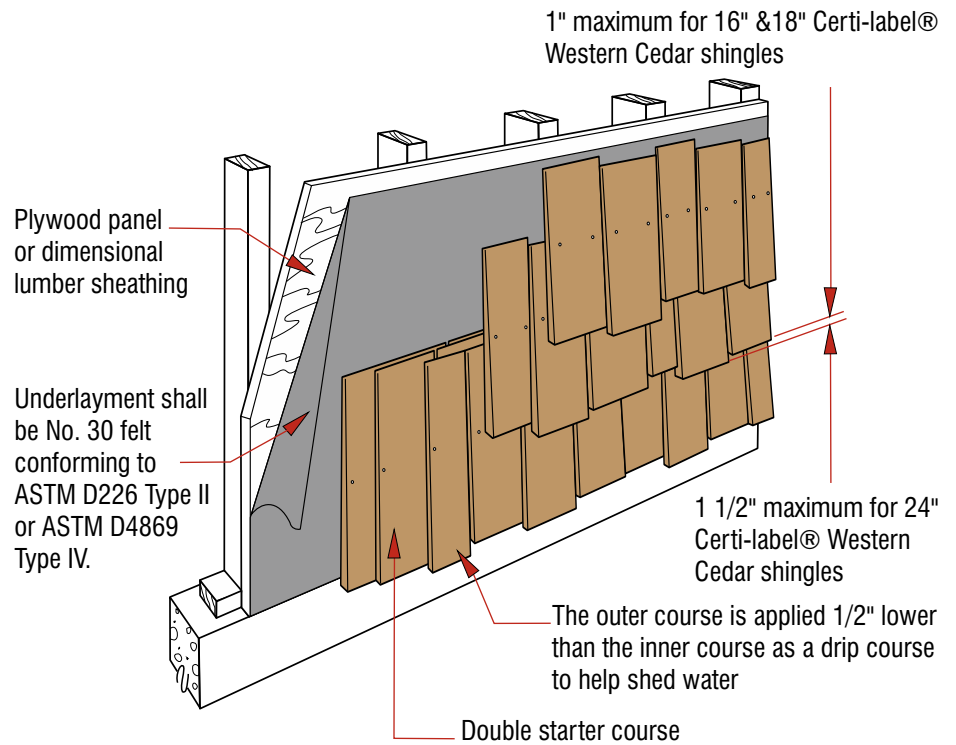

Figure 10: Staggered Coursing

Note: Butt nail all double coursed Certi-label® Western Cedar Sidewall shingles that are exposed more than their maximum single course exposure.

Ribbon Coursing

A double shadow line effect can be obtained by raising the outer course Certi-label® Western Cedar shingles approximately 1" above the undercoursing. Use Number 1 Grade Certi-label® Western Cedar shingles for undercoursing when applying ribbon coursing (Figure 11).

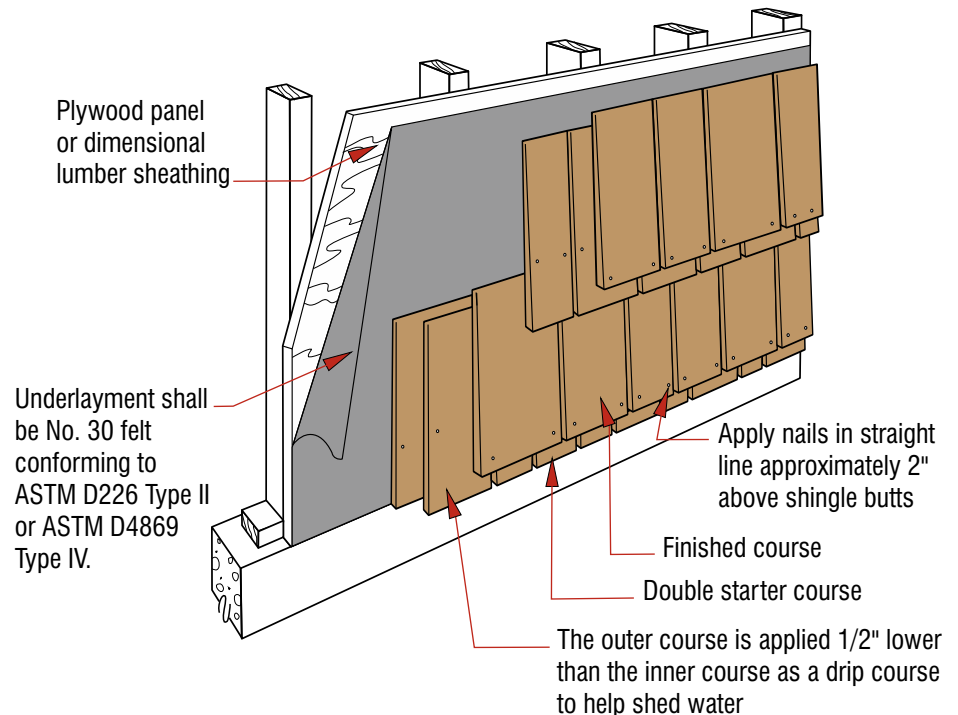

Figure 11: Ribbon Coursing

Design and Application Instructions

Re-walling

Once the old exterior wall material has been removed and the old nails or other protrusions cleaned away, the new wall can be applied. No. 30 felt (ASTM D226 Type II or ASTM D4869 Type IV) underlayment should be applied since it is new construction.

Over-walling

Applying Certi-label® Western Cedar shingles or shakes right over an old wall - whether wood, brick, stucco, or synthetic products - is easily done. It saves time involved in both removing the old exterior and in disposing of it. However, avoid nailing over vinyl or aluminum as they are not sufficiently strong to provide a proper support.

First, nail moulding strips on the face of existing window and door casings, flush with the outer edges. The Certi-label® Western Cedar shingles or shakes are then joined to the mouldings (Figure 12).

Over Beveled Siding - Applying a new Certi-label® Western Cedar shingle or shake wall over old beveled siding can be accomplished in either of two ways: 1) By filling in the low points of the wall with low grade lumber or plywood strips (called horse feathers) of appropriate thickness and thereby increasing the potential nailing surface, or 2) by nailing the Certi-label® Western Cedar shingles or shakes to the high points of the bevels of each course of the old wall, or of alternate courses [provided it does not result in weather exposure greater than is recommended (Figure 13)].

Ensure that the first course is properly attached. All Certi-label® Western Cedar shingle and shake product installation must meet nailing and exposure guidelines as detailed in this manual. It may be necessary to add occasional nailing strips.

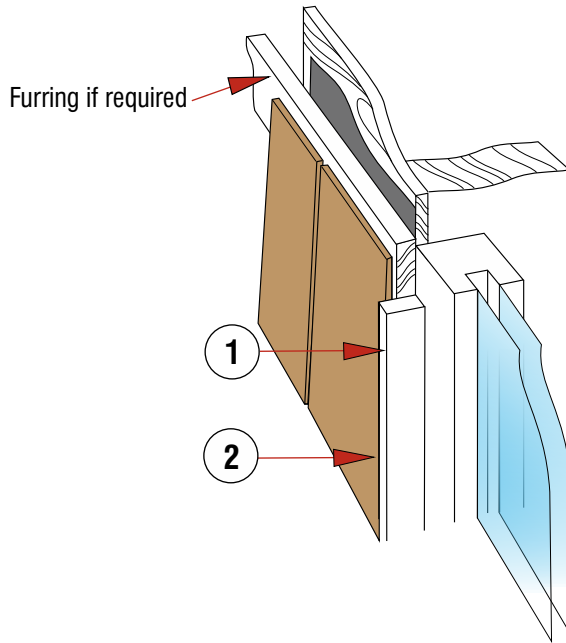

1. Apply new casing to bring Certi-label® Western Cedar shingles or shakes flush with surface
2. The integrity of the original flashing is to be utilized. Additional trim is considered to be decorative only. If the original window does not have good structural integrity, it must be removed and a new one installed. New casings are to be installed as part of proper wall construction as shown throughout this manual.

Figure 12: Typical Window and Door Casing Detail

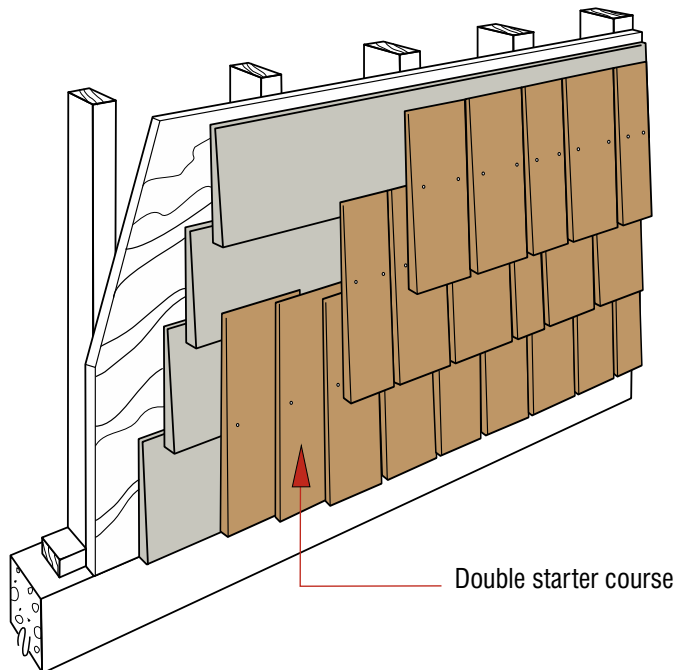

Figure 13: Over Beveled Siding Detail

Over Masonry or Foam Sheathing -

Masonry walls are easily covered, by vertically furring the walls and applying nailing strips (1" x 3" or 1" x 4") spaced according to the exposure and single/double course product design. When installing over masonry, the nailing strips should be fastened with special nails, driven between the bricks or blocks, so that the outer shingled wall will be firmly attached.

When installing over foam sheathing, vertical spacers shall be attached with fasteners long enough to penetrate through the foam sheathing and the underlying wood sheathing. Do not apply only to the foam sheathing as it is too weak to provide proper support. (Figure 14).

1" x 3" or 1" x 4" nailing strips spaced according to exposure of Certi-label® Western Cedar shingles or shakes, regardless of single or double course.

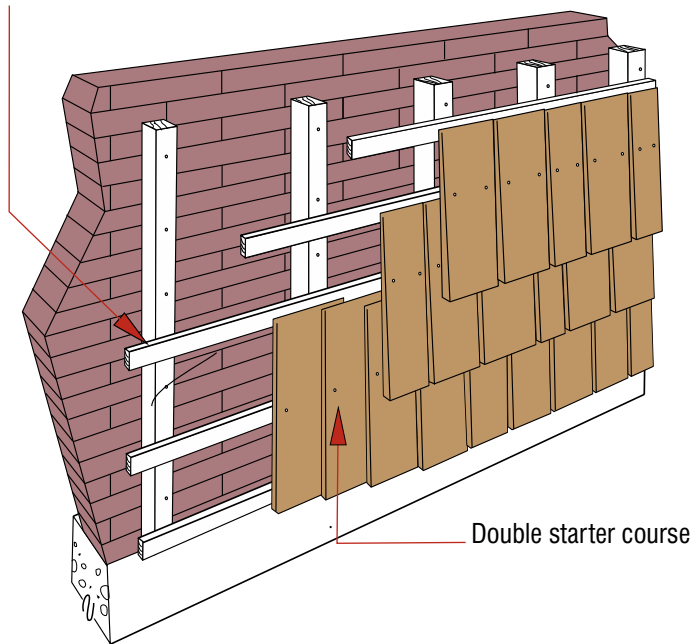

Figure 14: Over Masonry or Foam Sheathing Detail

Over Stucco - Nailing strips should be attached with nails long enough to penetrate the stucco and the underlying sheathing. Do not apply directly to the stucco, which is too weak to provide a proper support. If the old stucco is removed, new No. 30 felt (ASTM D226 Type II or ASTM D4869 Type IV) underlayment is then applied to the walls, and the shingling can proceed as in new construction (Figure 15).

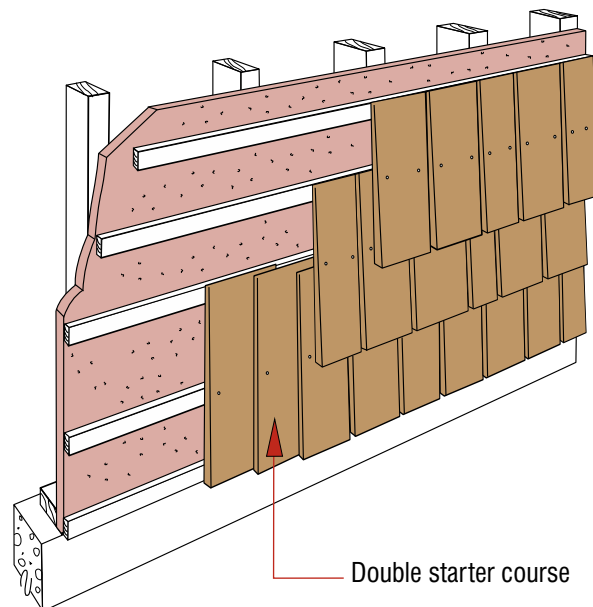

Figure 15: Over Stucco Detail

Design and Application Details

Certi-label® Western Cedar shingles or shakes are building materials that adapt easily to many different structural forms. Their use in interiors is practically unlimited, and a wide variety of imaginative effects can be achieved.

Certi-label® Western Cedar shingles or shakes can be readily applied over almost any interior wall surface, including wood, brick, plaster, or concrete. Nails, staples, or glue may be used as fasteners on interior wall projects. Certi-label® Western Cedar shingles or shakes may be attached directly to the interior wall providing it has sufficient holding qualities to support the fasteners. If this is not the case, they may be applied over spaced furring strips, which are fastened to the wall by nails or glue. As a general rule, the furring strips should be placed a distance apart equal to the desired exposure.

Calculate the number of courses by dividing the wall height (minus the height of the base board, if any) by the desired exposure. Mark the positions of the nailing strips on a furring strip, then transfer these measurements to the wall. Fasten 1" x 2" or 1" x 3" furring strips to the wall (e.g. by nailing them through the wall into the studs) at the positions marked. If the Certi-label® Western Cedar shingles or shakes are to be carried around the corner, make sure the furring strips line up (Figure 16).

Start with a double course at the bottom of the wall. Use two nails or staples in each Certi-label® Western Cedar shingle or shake placed so that the nail heads will be covered by the next course. The outer layer should overlap and conceal the side joints of the first course (Figure 17). Continue with single courses to the top of the wall. A straight edge tacked to the wall will keep the courses true and the exposure consistent. Alternately overlap the Certi-label® Western Cedar shingles or shakes on the outside corner to give a "laced" effect, then trim them flush with a block plane (Figure 18).

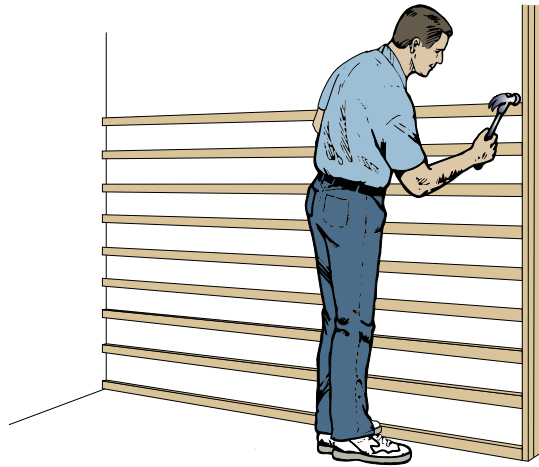

Figure 16: Furring Strip Detail

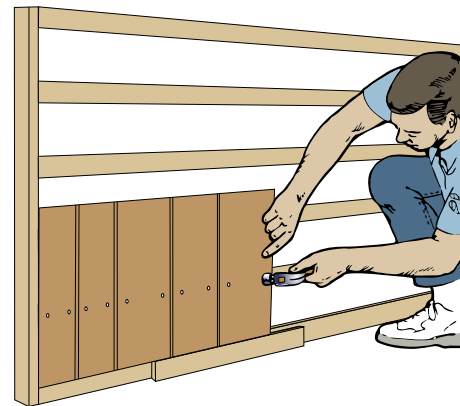

Figure 17: Starter Course

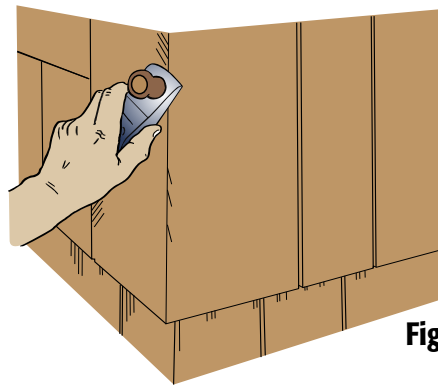

Figure 18: Corner Detail

Cut the Certi-label® Western Cedar shingles or shakes for the last course and discard the thin end. Glue or nail the last course in place to make a neat top edge. A moulding strip may be applied to cover nail heads and hide any irregularities in the ceiling (Figure 19).

The interior Certi-label® Western Cedar shingles or shakes can now be finished to suit almost any taste. Contact a reputable finish manufacturer for more details.



Figure 19: Top Course

General Application Notes

1. The contractor shall cover all wall surfaces with Certi-label® Western Cedar shingles or shakes bearing the Cedar Shake & Shingle Bureau's® official grade marked label.
2. Certi-label® Western Cedar shingles/shakes for outer courses shall be (specify grade and length).
3. Certi-label® Western Cedar shingles/shakes for undercourses shall be (specify grade and length).

Sidewall Application

4. Certi-label® Western Cedar sidewall shingles/shakes shall be (doubled or tripled) at foundation lines.
5. Number 1 Grade Certi-label® Western Red Cedar sidewall shingles shall be spaced apart 1/8" to 1/4"; Yellow Cedar shingles shall be spaced 3/16" to 5/16".

Note: Number 2 Grade Certi-label® Western Red Cedar shingles shall be spaced 1/4" to 3/8" apart.

6. Joints of Certi-label® Western Cedar shingles/shakes in any one course shall be offset not less than 1 1/2" from the joints in adjacent courses.
7. Certi-label® Western Cedar shakes on sidewalls shall be spaced 3/8" to 1/2" apart.
8. Certi-label® Western Cedar sidewall shingles/shakes shall be applied with a weather exposure of (specify in inches from exposure chart).

Fastening Sidewall Shingles/Shakes

9. Fasteners should be long enough to penetrate into the sheathing at least 3/4" or all the way through and driven

Maximum Sidewall Exposure Chart

Number One Grade Products			
Certi-label® Western Cedar Product	Grade	Single Course	Double Course
Certigrade®			
16" Shingles	1	7"	12"
18" Shingles	1	8"	14"
24" Shingles	1	10 1/2"	16"
16" R&R, sanded, Certigroove® Shingles	1	7"	12"
18" R&R, sanded, Certigroove® Shingles	1	8"	14"
24" R&R, sanded, Certigroove® Shingles	1	10 1/2"	16"
Certi-Split®			
18" Handsplit Shakes	1	8"	14"
24" Handsplit Shakes	1	10 1/2"	18"
18" Straight Split Shakes	1	8"	16"
24" Tapersplit Shakes	1	10 1/2"	18"
Certi-Sawn®			
18" Tapersawn Shakes	1	8"	14"
24" Tapersawn Shakes	1	10 1/2"	18"
Number Two Grade Products			
Certigrade®			
16" Shingles	2	6"	9"
18" Shingles	2	7"	10"
24" Shingles	2	9"	14"
16" R&R, sanded Shingles	2	6"	9"
18" R&R, sanded Shingles	2	7"	10"
24" R&R, sanded Shingles	2	9"	14"
Certi-Sawn®			
18" Tapersawn Shakes	2	7"	10"
24" Tapersawn Shakes	2	9"	14"

flush with the surface of the Certi-label® Western Cedar shingle or shake. In all applications, staples shall be concealed by the course above. Fasteners cannot be electrogalvanized as they will corrode and cause staining. For aesthetic reasons, nails are preferred for sidewall applications.

Note: Due to the diverse range of fastener requirements, please refer to pages 6-8 for fastener specifications.

Exterior Finishes (also known as Coatings)

There are a variety of paints, stains, and preservative treatments available for Certi-label® Western Cedar sidewall products. Certi-label® sidewall products are available pre-finished, (pre-primed or pre-stained) and natural (unfinished).

Please note: A detailed product finishing discussion is beyond the scope of this manual; however, a brief overview is presented below. It is critical to read the instructions on the finish product's container as well as follow the finish manufacturer's directions. All areas of the world present unique painting/staining challenges. Some of the topics you should discuss with your sidewall product manufacturer, finish manufacturer, and professional contractor include the following:

1. Product coverage
2. Surface preparation
3. Qualified finish contractors in your area
4. Certi-label® Western Cedar moisture content level recommended for your specific locale
5. Appropriateness of finish for Certi-label® Western Cedar sidewall products
6. Drying color versus sample chip color
7. Material Safety Data Sheet
8. Mildew resistance
9. UV resistance and water repellency
10. Exterior/Interior finish usage
11. Depth of finish penetration

12. Application method, including how to cover all sides of product, mixing/stirring (to prevent lap marks), temperature, brush versus spraying tools, and recommended proper clean up and disposal of all tools, brushes and rags. Talk to your finish manufacturer if you have questions about back-priming instructions for your particular project.

13. Price. Do not be fooled by a low price. Better quality brands tend to be more expensive. A cheap finish will usually cost more in the long run through quicker weathering, poorer coverage and less pigment. Use only the highest quality products from your finish manufacturer.

Quality finish manufacturers have technical help lines you can call (some are toll-free). Advice is also available via the Internet.

The CSSB Recognizes these General Types of Finishes:

Transparent finishes (penetrating oil-based): clear, allow natural grain to show through, may also include paintable water repellent preservatives. Such treatment can possibly, depending upon the product, inhibit mildew growth as well as rapid change in color due to weathering.

Semi-transparent and semi-solid stains (penetrating oil-based): have some pigment, but allow some wood grain to show.

Paint or solid stain: provide opaque coverage, allowing little to no wood grain to show.

Certi-label® Western Cedar Sidewall Finishing Systems: Preferred Paint System

Step 1: Factory or field applied alkyd oil or latex stain blocking primers on all surfaces.

Step 2: Field-applied top coat of highest quality 100% acrylic latex paint. This type of top coat is more flexible and more resistant to blistering and cracking. The best protection against extractive bleeding is the application of an oil-based, stain-blocking primer before the top coat is applied.

OR

Less Durable Paint System

Step 1: Factory or field applied alkyd oil or latex stain blocking primers on all surfaces.

Step 2: Field-applied oil-based or alkyd top coat.

CSSB member manufacturers do supply factory-primed products. These products are usually more cost-effective than on-site priming.

Stains

Use oil-based stains only. CSSB member manufacturers can factory-apply a coat of semi-transparent or semi-solid oil-based stain. This process is usually more cost-effective than on-site staining. Further enhancing the natural durability of Certi-label® Western Cedar shingles and shakes, some CSSB members offer pass-through finish warranties on their factory finished sidewall shingles and shakes. These can be further enhanced by application of a final, field-applied top coat. Contact participating CSSB members for details.

To Accelerate the Weathering Process

To hasten the weathering process, apply a bleaching oil finish.

Additional information on finishing as well as cleaning/maintenance can be found at www.cedarbureau.org

How Soon to Finish

Generally finish products **IMMEDIATELY** after installation **PROVIDING** that the moisture content is appropriate for both the finish product being used and your locale. If the finish is not applied promptly, adhesion will be compromised (unless additional surface preparation is undertaken).

If you have installed a natural product (unfinished), apply your finish before rain and other moisture are absorbed. Ensure that you account for high humidity concerns.

If you are using a pre-finished product (where finish is applied at the manufacturing plant), ensure that the product is thoroughly dried before applying a top finish coat.

In all instances drying time varies from region to region. Excessive moisture will limit finish adhesion. Check with your professional contractor, finish manufacturer and/or sidewall product manufacturer for assistance.

Surface Cleaning

There are products that claim to be effective for removing dirt, airborne pollution marks, mildew and prior finishes. If you clean the surface prior to finishing, ensure that it is allowed to dry to the finish manufacturer's recommended moisture content level before applying a new finish. Contact your finish manufacturer for more details.

Extractive Bleeding

Extractive bleeding is characterized by the tannins in the wood being dissolved in moisture and migrating to the surface of the product. Rain will sometimes wash these stains away; however if left to weather, the sun can cause polymerization, requiring the addition of a tannin blocker and new top coat of finish (ensure proper surface preparation before applying new top coat) once the moisture problem has been solved. Compounds containing oxalic acid appear to be the most effective at removing extractive bleeding stains: ensure you use proper safety precautions and follow the oxalic acid compound manufacturer's application directions.

Extractive bleeding does not signify failure of the applied finish, but instead is found in applications where a source of moisture is present. Extractive bleeding is not a manufacturing defect nor is it a finish defect; it is a natural phenomenon that occurs in applications. Tannin blocking products help, however, the CSSB does not provide any finish warranty. Check with your sidewall product manufacturer, finish manufacturer, and professional contractor for more assistance.

The CSSB does not warrant this information or instruction regarding finishes. If you see an attractive job that has endured in your locale, inquire about the type of finish used.

Once Certi-label® Western Cedar shingles and shakes are pressure-impregnated treated you must contact the treatment company to determine if a finish, such as paint or stain, is allowable. If there is any confusion whatsoever it is highly recommended that you contact both your sidewall product manufacturer and the finish manufacturer.

Additional information on finishing as well as cleaning/maintenance can be found at www.cedarbureau.org

Certigrade Shingles® - Coverage (Number 1 Grades)

Approximate coverage, in square feet, of one square (4-bundle roof-pack) of shingles, applied at indicated weather exposures. (Some exposures on this chart are not acceptable for single course application. Consult the maximum exposure table on page 16 for more details).

Exposure →	3½"	4"	4½"	5"	5 ½"	6"	6 ½"	7"	7½"	8"	8½"	9"	9 ½"	10"
Length and Thickness														
16" x 5/2" ↓	70	80	90	100	110	120	130	140	150	160	170	180	190	200
18" x 5/2¼"	–	72½	81½	90½	100	109	118	127	136	145½	154½	163½	172½	181½
24" x 4/2"	–	–	–	–	73½	80	86½	93	100	106½	113	120	126½	133

Certigrade Shingles® - Coverage (Number 1 Grades), continued

Approximate coverage, in square feet, of one square (4-bundle roof-pack) of shingles, applied at indicated weather exposures. (Some exposures on this chart are not acceptable for single course application. Consult the maximum exposure table on page 16 for more details).

Exposure →	10½"	11"	11½"	12"	12½"	13"	13½"	14"	14½"	15"	15½"	16"
Length and Thickness												
16" x 5/2" ↓	210	220	230	240	–	–	–	–	–	–	–	–
18" x 5/2¼"	191	200	209	218	227	236	245½	254½	–	–	–	–
24" x 4/2"	140	146½	153	160	166½	173	180	186½	193	200	206½	213

Certigroove® Shingles/Rebutted & Rejointed Shingles - Coverage (Number 1 Grades)

Approximate coverage, in square feet, of one single-carton sidewall square of machine grooved shingles, rebutted & rejointed shingles, and sanded face shingles applied at indicated weather exposures. (Some exposures on this chart are not acceptable for single course application. Consult the maximum exposure table on page 16 for more details).

Exposure →	6"	7"	8"	9"	10"	11"	12"	13"	14"	15"	16"
Length ↓											
16" ↓	50	59	67	76	84	93	100	–	–	–	–
18"	43	50	57	64	72	79	86	93	100	–	–
24" 2 carton wall square	37	44	50	56	62	69	75	81	87	94	100
24" 4 carton wall square	74	88	100	112	124	138	150	162	174	188	200

Coverage Guidelines

- Sidewall squares are calculated in a different manner than roof squares. The number of cartons in a square depends upon the product type. Check with your supplier for more details.
- Remember to deduct window and door areas from coverage calculations.

Product Coverage Calculations

Ensure you have the following information:

1. Size of wall area you are trying to cover, measured in square feet.
2. Application method and exposure to be used
3. Product type used
4. Amount of product in each box (packaging)

Your supplier will be glad to assist you. As usual, always check with your local building official for requirements in your area.

Sidewall Shingle Packaging

- Cartons are made of cardboard, and must be kept dry.
- CSSB member product will be labeled with the Certi-label® on the carton.
- Mills pack in 1/2 carton and full carton sizes. Check with your supplier for more details.
- **Before starting please read the instructions printed on the carton.**

CHECK WITH YOUR SUPPLIER
FOR MORE DETAILS

Certi-Split® Shakes - Coverage (Number One or Premium Grades)

Approximate coverage, in square feet, of one square of shakes applied at indicated weather exposures. (Some exposures on this chart are not acceptable for single course application. Consult the maximum exposure table on page 16 for more details).

Exposure →	7"	8 1/2"	10"	11 1/2"	14"	16"	18"
Shake Type, Length and Thickness ↓							
18" x 1/2" Handsplit-and-Resawn Mediums	70	85	100	115	140	–	–
18" x 3/4" Handsplit-and-Resawn Heavies	70	85	100	115	140	–	–
18" Tapersawn	70	85	100	115	140	–	–
24" x 3/8" Handsplit & Resawn	70	85	100	115	140	160	180
24" x 1/2" Handsplit-and-Resawn Mediums	70	85	100	115	140	160	180
24" x 3/4" Handsplit-and-Resawn Heavies	70	85	100	115	140	160	180
24" Tapersawn	70	85	100	115	140	160	180
24" x 1/2" Tapersplit	70	85	100	115	140	160	180
18" x 3/8" True-Edge Straight-Split (4 bundle square)	50	60	71	82	100	–	–
18" x 3/8" Straight-Split (5 bundle square)	82	100	118	135	165	–	–
24" x 3/8" Straight-Split	70	85	100	115	140	160	180

Starter Course: Underlying course can be the Number 1 Grade product used on outer course or a lower grade product.

Please note: 1) Handsplit shakes are also known as Handsplit-and-Resawn shakes.

2) Do not interlay shakes or shingles with felt on sidewall applications.

Coverage Guidelines

- Sidewall squares are calculated in a different manner than roof squares.
- Remember to deduct window and door areas from coverage calculations.

Product Coverage Calculations

Ensure you have the following information:

1. Size of wall area you are trying to cover, measured in square feet.
2. Application and exposure to be used
3. Product type used
4. Amount of product in each box or bundle

Your supplier will be glad to assist you. Ask for warranty requirements including product labels before purchasing product. As usual, always check with your local building official for requirements in your area.

Sidewall Shake Packaging

- Shakes are packaged in bundles, secured with a metal strap. Each bundle will have a Certi-label® underneath.
- While most 18" shakes are packed in bundles of 12 courses each side (12/12) they may be packed 9/9. This will alter the number of bundles required to cover 1 square. Check with your supplier for more details.

For example: 18" shake bundles, 12/12 pack, 5 bundles, should cover 100 square feet at 7 1/2" exposure.

9/9 pack, 5 bundles, should give 75% coverage of a square at 7 1/2" exposure. When ordering check with your supplier to confirm bundle size.

CHECK WITH YOUR SUPPLIER
FOR MORE DETAILS

©2020 404

CERTIGRADE®

Red Cedar Shingles

- 100% Edge Grain - 100% All Clear -
- 100% Heartwood -

CEDAR SHAKE & SHINGLE BUREAU

THE RECOGNIZED AUTHORITY SINCE 1915
SUMAS, WASHINGTON (604) 820-7700

**LIFETIME LIMITED WARRANTY AVAILABLE FROM CSSB MEMBER MANUFACTURER BELOW
WHEN APPLIED BY A CSSB MEMBER CONTRACTOR/INSTALLER**

<p>4 → Quality Control Agency Logo</p>	 Cedar Shake & Shingle Bureau 030640	<p>10 ← Building Code Standards</p> <p>11 ← Product Testing Numbers</p>
---	--	---

Litho in Canada www.cedarbureau.org Country of Manufacture

<p>6 → Mill Name Mill Location Mill Phone Number</p>	<p>12 ←</p>  7 20454 00004 2
---	---



<p>7 → PERFECTION</p> <p>8 → 18" x 5 / 2 1/4" (457 mm X 5 / 57.0 mm)</p>	<p>14 ←</p> <p>15 ←</p> <table border="1" style="margin: auto;"> <tr> <th colspan="2">COVERAGE CHART</th> </tr> <tr> <th colspan="2">100 sq. ft. (9.30 m²)</th> </tr> <tr> <th>BUNDLES</th> <th>EXPOSURE</th> </tr> <tr> <td style="text-align: center;">4</td> <td style="text-align: center;">5 1/2" (140.0 mm)</td> </tr> </table>	COVERAGE CHART		100 sq. ft. (9.30 m ²)		BUNDLES	EXPOSURE	4	5 1/2" (140.0 mm)
COVERAGE CHART									
100 sq. ft. (9.30 m ²)									
BUNDLES	EXPOSURE								
4	5 1/2" (140.0 mm)								

- | | |
|--|---|
| <ol style="list-style-type: none"> 1. The "Certi" Brand Name - Your Quality Assurance 2. Product Type 3. Product Grade 4. Independent, 3rd Party, Quality Control Agency 5. This Number Shows Compliance with Total Quality Manufacturing System 6. Mill Name, Location and Phone Number 7. Industry Product Description | <ol style="list-style-type: none"> 8. Product Dimensions 9. Cedar Bureau Label Number 10. Building Code Compliance Numbers 11. Product Performance Tests Passed 12. Label Identification Number 13. UPC Code 14. Coverage Chart and Recommended Exposure 15. Application Instructions on Reverse Side |
|--|---|

CEDAR SHAKE & SHINGLE BUREAU® HISTORY



1920s: Chief Inspector Fred Monte inspecting product

On June 9, 1915, at a meeting of the Trustees of the West Coast Lumber Manufacturers Association, it was agreed to establish a branch of the association to serve those members who manufactured shingles. Our influence grew, and as we survived both the Great Depression and World War II, manufacturers continued their quality commitment. In 1963, the organization merged with the Handsplit Shake Bureau to become the Red Cedar Shingle & Handsplit Shake Bureau.

Manufacturers' product lines continued to broaden and, in 1988, the members changed the organization's name to the Cedar Shake & Shingle Bureau® ("CSSB"). In the late 1980s, mill quality control inspections were subcontracted to independent, third party quality control agencies.

Each year the CSSB's staff answer thousands of technical questions and product selection queries. Our proud history, quality reputation and dedicated members provide excellent Certi-label® cedar shake and shingle roofing and siding products.



Contact us for more information:

TEL: 604-820-7700
FAX: 604-820-0266
www.cedarbureau.org
info@cedarbureau.com

US Address	Canadian Address
PO Box 1178 Sumas, WA 98295-1178	300 – 34334 Forrest Terrace Abbotsford, BC V2S 1G7

This manual shows Cedar Shake & Shingle Bureau® recommended procedures as of the manual's print date. It is advisable to contact the Cedar Shake & Shingle Bureau® to ensure that you are using the latest available information.

Cedar Shake & Shingle Bureau®, the CSSB logo® ("C" with shingles/shakes), Blue Label®, Certigrade®, Certigroove®, Certi-Cut®, Certi-Guard®, Certi-label®, Certi-Last®, Certi-Ridge®, Certi-Sawn®, Certi-Split®, Certi-Wood®, Envirosmart® and The Crowning Touch of Quality & Design® are all registered trademarks of the Cedar Shake & Shingle Bureau®.



Forestry Innovation
Investment®